

Product: X-LINE SLIGHT SPOTS UP&DOWN LED 5500/6600 PLX-T/MICRO-PRM E / 2x 600 15° E 04 830 / L-1723MM S-1,5M TWO CIRCUIT

Index: 19.4401.441E.04

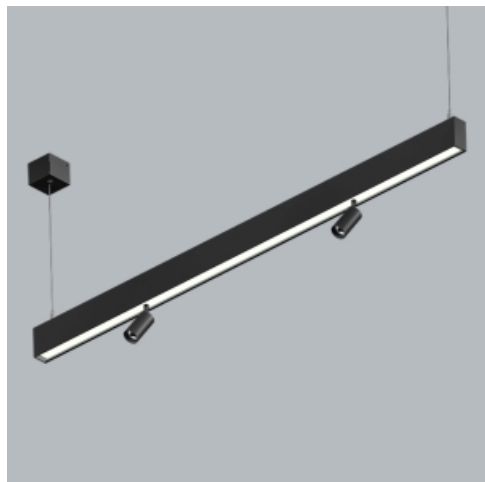

Description

X-LINE SLIGHT SPOTS is a variant of our popular X-Line linear lighting series, now featuring a combination of general and accent lighting. This version integrates compact yet powerful projectors from LUXIONA offer (Luxcan Micro) with a 15° optical beam (PMMA lens), allowing 360° horizontal and 90° vertical rotation, ideal for highlighting any detail in the space. These projectors are also featured in various Luxiona products, achieving a cohesive aesthetic across projects that use multiple products. Luminaires, available in suspended option, come with opal or micro-prismatic diffuser, in 3000K and 4000K colour temperatures, and CRI80. They are available in three finishes (white, black, and silver) and three lengths (1162, 1723, and 2284mm). It is also possible to choose between non-dimmable drivers or DALI dimmable options. In addition to all standard configurations, this product can be customised in LED colour temperature, CRI, and beam angles (24°, 36°, or 50°) to fit specific lighting needs.

Product information

Category	Surface mounted luminaires
Family	X-LINE SLIGHT SPOTS UP&DOWN LED
Name	X-LINE SLIGHT SPOTS UP&DOWN LED 5500/6600 PLX-T/MICRO-PRM E / 2x 600 15° E 04 830 / L-1723MM S-1,5M TWO CIRCUIT
Index	19.4401.441E.04
EAN	5902107644758



Light and electrical data

Light source	LED
Luminous flux LED [lm]	12244 / 1294
LED power [W]	62,7 / 8,6
Luminaire luminous flux [lm]	9648 / 1020
Power of luminaire [W]	70,2 / 10,8
Luminaire's light efficiency [lm/W]	137,4 / 94,4
Color of the light [K]	3000
CRI	>80
SDCM (LED sources)	3
Beam angle [°]	(C0-C180) / (C90-C270) - 86,2° / 111° // (C0-C180) / (C90-C270) - 17,8° / 19,8°
Photobiological risk class (IEC/EN 62471)	RG0
Protection against electric shock	I
Protection degree	IP40
Voltage	220..240 V, 50..60 Hz
Lifetime of LED sources [h]	80000
Lx/By	L80/B10
Operating temperature range [°C]	5 ÷ 35
Driver	standard on/off (E) / standard on/off (E)
Circuit load capacity	8 (B10), 13 (B16), 11 (C10), 18 (C16)

Mechanical data

□ ± I
B
H



Assembly	surface mounted on slings
Material	aluminum
Color	RAL 9005 (black)
Diffuser	PLX-T/Micro-PRM (transparent PMMA/micro-prismatic diffuser PMMA) [up/down] / optical system based on PMMA lenses
Impact resistant	IK04
Dimensions [mm]	1723 x 34 x 68

A graph of light

