

**Product:** X-LINE SLIM UP&DOWN LED 2600/2600 PC/OPTICS-WIDE E 34 830 / L-1144MM S-1,5M

**Index:** 19.4181.2211.34

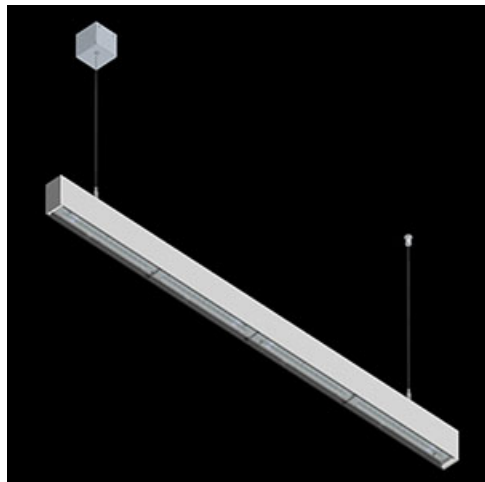

## Description

The luminaire is made of aluminum profile. Its characteristic feature is the light distribution in the upper and lower half-space. Comparing to the traditional X-Line LED, size of the luminaire has been reduced, and all construction has been closed in a narrow 48 mm profile, which gives now a more elegant form of the product. The X-Line Slim uses a PC and Micro-PRM opal diffuser (intended only for the lower beam) or PC and lenses (intended only for the lower beam). All of this allows to manipulate light and create lighting systems, facilitating the creation of comfortable vision in the interiors and their aesthetic appearance. The X-Line Slim luminaire is designed for mounting on suspensions. LED sources distributing light in both the lower and upper half-space are connected into one circuit and use a common, single power supply.

## Product information

|          |   |
|----------|---|
| Category | Surface mounted luminaires  |
| Family   | X-LINE SLIM UP&DOWN LED   |
| Name     | X-LINE SLIM UP&DOWN LED 2600/2600 PC/OPTICS-WIDE E 34 830 / L-1144MM S-1,5M |
| Index    | 19.4181.2211.34   |



## Light and electrical data

|   |   |
|---|---|
| Light source                              | LED                                     |
| Luminous flux LED [lm]                    | 5076                                    |
| LED power [W]                             | 24,8                                    |
| Luminaire luminous flux [lm]              | 3857,8                                  |
| Power of luminaire [W]                    | 28,2                                    |
| Luminaire's light efficiency [lm/W]       | 136,8                                   |
| Color of the light [K]                    | 3000                                    |
| CRI                                       | >80                                     |
| SDCM (LED sources)                        | 3                                       |
| Beam angle [°]                            | (C0-C180) / (C90-C270) - 101,8° / 88,4° |
| Photobiological risk class (IEC/EN 62471) | RG0                                     |
| Protection against electric shock         | I                                       |
| Protection degree                         | IP40                                    |
| Voltage                                   | 220..240 V, 50..60 Hz                   |
| Lifetime of LED sources [h]               | 100000                                  |
| Lx/By                                     | L80/B10                                 |
| Operating temperature range [°C]          | 5 ÷ 35                                  |
| Driver                                    | standard on/off (E)                     |
| Power factor cos φ                        | >0,95                                   |
| Circuit load capacity                     | 25 (B10), 40 (B16), 39 (C10), 62 (C16)  |

**Mechanical data**



|                  |   |
|------------------|---|
| Assembly         | surface mounted on slings   |
| Material         | aluminum  |
| Color            | RAL 9016 (white)  |
| Diffuser         | PC/OPTICS (opalescent polycarbonate/optical system based on lenses) [up/down] |
| Impact resistant | IK04  |
| Dimensions [mm]  | 1144 x 48 x 70  |

**A graph of light**

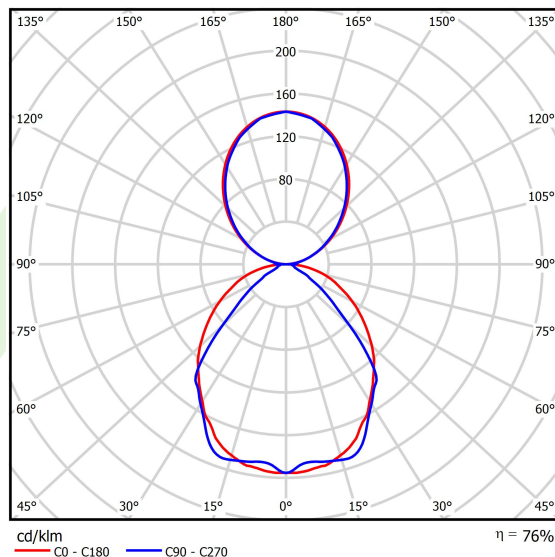
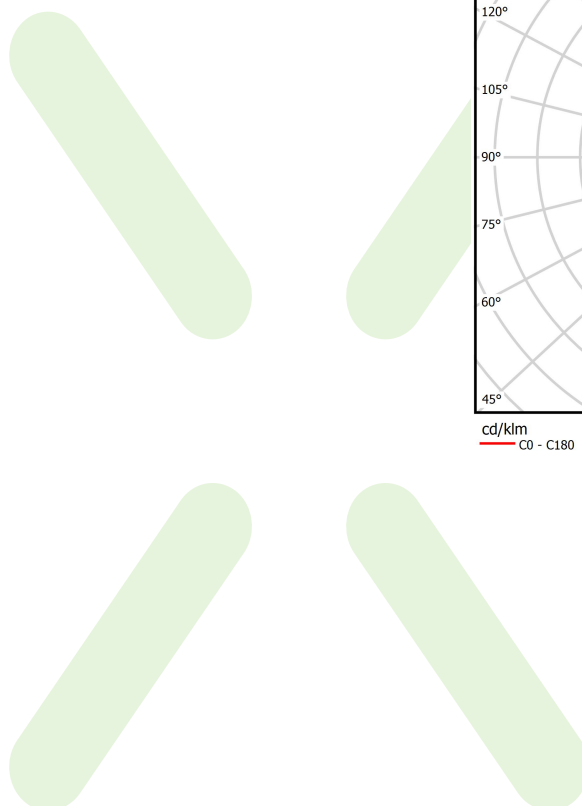

## Accessories

Index 6E1-500KW34K-3

Name SUSPENSION NEW TYPE-A+B 34  
LENGHT 1,5M WIRE 3X SET

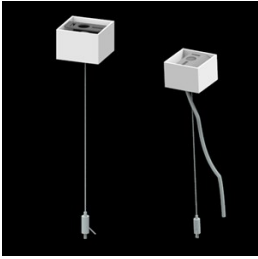

Index 6E1-8670-B-1,5-3X

Name SUSPENSION NEW TYPE-F  
LENGHT-1,5 METER WIRE 3X 1-  
POINT



Index 19.3272.1205.00

Name SUSPENSION NEW TYPE-E  
LENGHT-1,5 METER WITHOUT  
WIRE 1-POINT

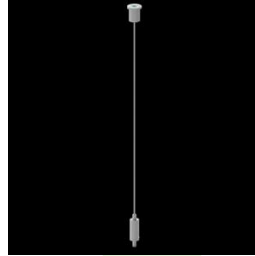

Index 6E1-500KWB34K-3

Name SUSPENSION NEW TYPE-A+E 34  
LENGHT 1,5M WIRE 3X SET

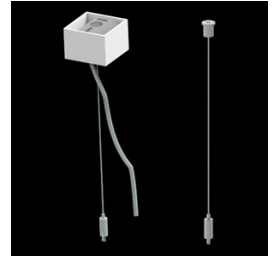

Index 6E1-9875-4-1,5-3X

Name SUSPENSION NEW TYPE-D  
LENGHT-1,5 METER WIRE 3X 1-  
POINT

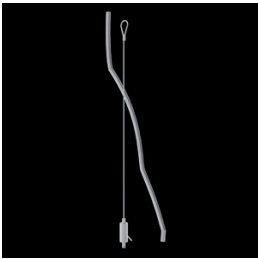

Index 6E1-9875-3-1,5

Name SUSPENSION NEW TYPE-C  
LENGHT-1,5 METER WITHOUT  
WIRE 1-POINT

