

Product: X-LINE SLIM L-DOWN LED 2600 OPTICS-WIDE E 34 830 / L-1144MM S-1,5M

Index: 19.4090.1311.34



Description

The luminaire is made of aluminum profile. There is only lower half-space light distribution (L-DOWN). Comparing to the traditional X-Line LED, size of the luminaire has been reduced, and all construction has been closed in a narrow 48 mm profile, which gives now a more elegant form of the product. The X-Line Slim uses a PLX or Micro-PRM opal diffuser or lenses. All of this allows to manipulate light and create lighting systems, facilitating the creation of comfortable vision in the interiors and their aesthetic appearance. The X-Line Slim luminaire is designed for mounting on suspensions.

Product information

Category	Surface mounted luminaires
Family	X-LINE SLIM LED
Name	X-LINE SLIM L-DOWN LED 2600 OPTICS-WIDE E 34 830 / L-1144MM S-1,5M
Index	19.4090.1311.34



Light and electrical data

Light source	LED
Luminous flux LED [lm]	2538
LED power [W]	12,4
Luminaire luminous flux [lm]	2106,5
Power of luminaire [W]	14,1
Luminaire's light efficiency [lm/W]	149,4
Color of the light [K]	3000
CRI	>80
SDCM (LED sources)	3
Beam angle [°]	(C0-C180) / (C90-C270) - 101,8° / 88,4°
Photobiological risk class (IEC/EN 62471)	RG0
Protection against electric shock	I
Protection degree	IP40
Voltage	220..240 V, 50..60 Hz
Lifetime of LED sources [h]	100000
Lx/By	L80/B10
Operating temperature range [°C]	5 ÷ 35
Driver	standard on/off (E)
Power factor cos φ	>0,95
Circuit load capacity	25 (B10), 40 (B16), 39 (C10), 62 (C16)

Mechanical data



Assembly	surface mounted on slings
Material	aluminum
Color	RAL 9016 (white)
Diffuser	OPTICS (optical system based on lenses)
Impact resistant	IK04
Dimensions [mm]	1144 x 48 x 70

A graph of light

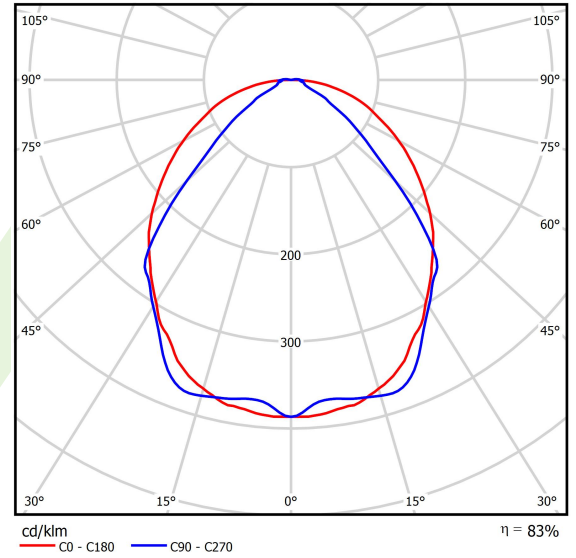

Accessories

Index 6E1-500KW34K-3

Name SUSPENSION NEW TYPE-A+B 34
LENGHT 1,5M WIRE 3X SET



Index 6E1-8670-B-1,5-3X

Name SUSPENSION NEW TYPE-F
LENGHT-1,5 METER WIRE 3X 1-
POINT



Index 19.3272.1205.00

Name SUSPENSION NEW TYPE-E
LENGHT-1,5 METER WITHOUT
WIRE 1-POINT



Index 6E1-500KWB34K-3

Name SUSPENSION NEW TYPE-A+E 34
LENGHT 1,5M WIRE 3X SET



Index 6E1-9875-4-1,5-3X

Name SUSPENSION NEW TYPE-D
LENGHT-1,5 METER WIRE 3X 1-
POINT



Index 6E1-9875-3-1,5

Name SUSPENSION NEW TYPE-C
LENGHT-1,5 METER WITHOUT
WIRE 1-POINT

