

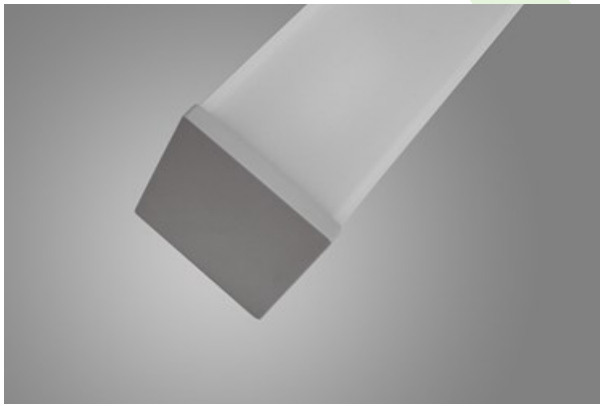

X-LINE E27

Surface mounted luminaires

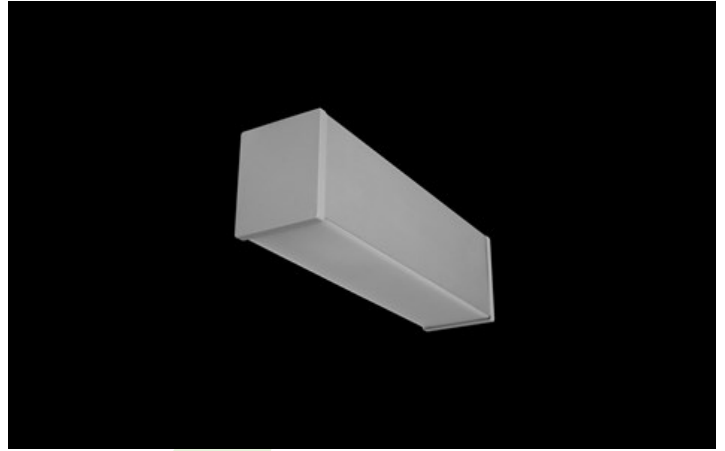

Luminaire for replaceable sources with a popular E27 base made of aluminum profile equipped with a opal diffuser. Installation depending on the version is ceiling mounted (X-Line Surface) or on the wall (X-Line Kinkiet). The luminaire must be equipped with a Parathome Stick source for the E27 base.

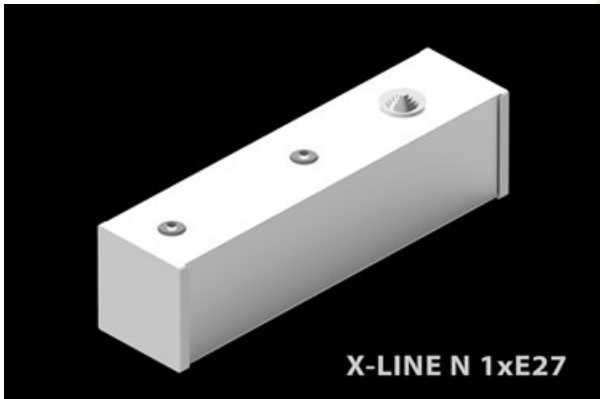



Main parameters:

Name	Luminous flux LED [lm]	Power of luminaire [W]	Color [K]	Dimensions A x B x H [mm]
X-LINE WALL 1xE27	depending on source	depending on source	depending on source	250 x 63 x 74
X-LINE SURFACE 1xE27	depending on source	depending on source	depending on source	250 x 63 x 74

Technical drawing:

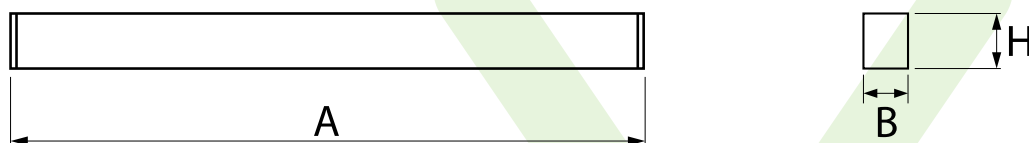

Light and electrical features:

Light source	LED E27 PARATHOM STICK (not included)
Voltage	220..240 V, 50..60 Hz
Lifetime of LED sources [h]	depending on source
Lx/By	depending on source
CRI	depending on source
SDCM (LED sources)	depending on source
Driver	none

* Variant to specify when ordering

Mechanical features:

Assembly	mounted on wall surface mounted on ceiling
Material	aluminum
Color	RAL 9005 (black) anodised aluminum RAL 9016 (white) *
Diffuser	PLX (PMMA opal)



Note: The power shown refers to the whole system (tolerance +/- 10%).
The given luminous flux refers to LED light sources (tolerance +/- 10% depends on the value of the colour temperature).
Technical data may be changed. Photos of the luminaires may differ from reality.
Date of last update: 17-04-2026